

Goedhart FC38S



Goedhart FC38D



Goedhart FC38L



Goedhart FC38

Standard air coolers

Cu/Al

R404A - Coolants



Goedhart FC38

The range GEA Goedhart FC38 standard ceiling mounted air coolers are standard air coolers for cooling and freezing applications (FC38S), working/preparation rooms and storage rooms for humidity sensitive products (FC38D) and for cold storage rooms with height limitation (FC38L).

The standard FC38 aircoolers are suitable for all known refrigerants and not corrosive coolants, with the exception of NH3.

Type description

FC38Si(dx) 6.2.40.7-230-E

| | | |
|-------------------------------------|-----|----------------------|
| FC38S = Ceiling mounted air coolers | 2 | = Number of fans |
| FC38D = Dual discharge air coolers | | |
| FC38L = Extra low air cooler | 40 | = Fan diameter in cm |
| i = internally enhanced tubes | 7 | = Fin spacing |
| p = plain tubes | | |
| (dx) = R404A | 230 | = 1x230V Fan tension |
| (G) = coolant | 400 | = 3x400V Fan tension |
| 6 = number of tubes deep | E | = Electrical defrost |
| | H | = Hot gas defrost |

General features

Coil block

- Tube distance : 38x33 mm versprongen
- Tubes : 12mm o.d copper tube
- : I= internally enhanced tubes for refrigerants (dx)
P= internally plain tubes for coolants(G) and refrigerants (dx)
- Fins : aluminium HT-fins
- Fin spacing : 4 mm : Suitable for applications with air temperatures above 0°C and with expected limited frost
: 7 mm : Suitable for applications with air temperatures below 0°C and expected frost
- A good thermal with the fins contact because the copper tubes are mechanically expanded into fully collared aluminium fins.
- The suction header is executed with a Schröder valve for testing applications
- All coil blocks for refrigerants are pressure tested to 40 bars. All coil blocks for coolants are pressure tested to 15 bars.
- FC38 aircoolers are supplied with a light overpressure charge.

General features

Casing

- Standard refrigerant connections are fixed on the left hand side of the unit when looking with the direction of the air flow.
- Construction suitable for mounting to the ceiling.
- The FC38 casing is made from galvanized sheet steel, with exception of:
 - FC38S drip tray is hinged and made from light aluminum.
 - FC38D has a fixed galvanized drip tray.
 - FC38L drip tray is hinged and made from light aluminum.
- The fans of the FC38D are mounted to the outside of the drip tray of the air cooler and are wired.
- Goedhart FC38SB and FC38L air cooler is executed with a short air conduction plate as standard.
- The casing has a corrosion resistant white epoxy spray finish (RAL 9003).
- Almost all fixing materials are made of stainless steel to prevent corrosion.
- A possible hot gas spiral or electric defrost elements will be fixed to the bottom side of the coil

Standard options

| Optional extra's | FC38S | FC38D | FC38L |
|--------------------------|-------|-------|-------|
| Draw through execution | • | | |
| Insulated drip tray | • | | |
| StSt casing | • | • | • |
| Goldlack fins (4 / 7 mm) | • | • | • |
| Almg fins (4 mm) | • | • | • |

Options on request

| Optional extra's | FC38S | FC38D | FC38L |
|---------------------|-------|-------|-------|
| Hot gas defrost | • | | |
| Warm glycol defrost | • | | |
| Fan heating | • | | • |
| Splash plate | • | | |
| StSt tubes | • | • | • |

P.E.D.

All air coolers produced by Goedhart comply with the Pressure Equipment Directive 97/23/EC. PED certificates can be downloaded from www.goedhart.nl.

Guarantee

Goedhart gives in conformity with her general conditions of delivery the following guarantee period on the Goedhart FC38 air coolers:

- within a 12 month period of product use
- at the latest within 18 months after the time of delivery.

Sound data

The mean sound pressure (LpA @ 3m ± 2 dB (A)) each air cooler is a calculated indication value according to the EN13487 standard parallel pipe. Goedhart uses the fan manufacturer's sound power level (LwA) at the inlet side of the fan. Changes to or by the fan or the product, affect the sound, in these cases, consult the manufacturer for the new indication value. In critical sound requirements, we advise you to consult an expert.

Defrost systems

For room temperatures where ripe formation can be expected and where the coil can not be defrosted by the room air, electrical or hot gas defrost is necessary

Electrical defrost

On request FC38 can be provided with electrical defrost. FC38 is always delivered with heavy defrost. The heater elements are rated for 220/240 V and are 400/420 V with zero wire supply. The stainless steel heater elements are fitted in the coil block in inner tubes which form a highly conductive medium between the heaters and the fins. In the drip-tray, the heater elements are fitted to the bottom side of the underside of the aluminum inner tray. The heater elements in the coil block are removable from the header side of the unit, whilst the tray heater elements can be removed once the outer tray has been taken off.

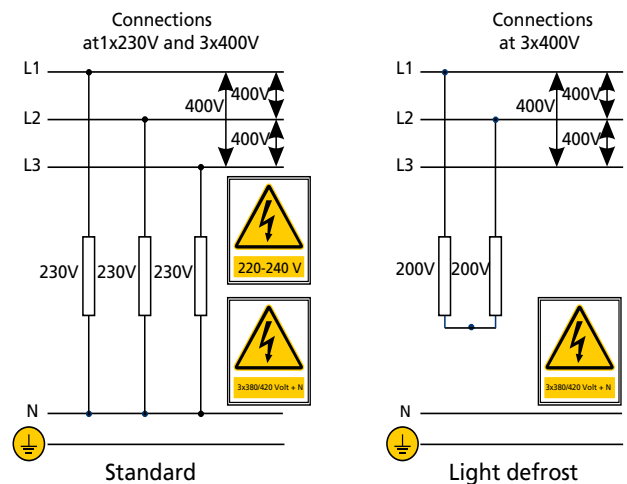

Hot gas defrost

The coil block is suited for hot gas defrost (hot gas supply through the suction header). The drip tray can be provided with a copper hot gas spiral, which is enclosed in special aluminum profiles, which are rigidly secured to underside of the aluminum inner tray.

Mounting & Maintenance

FC38 is delivered in a wooden crate. FC38S will be delivered with the separate drip-tray. When crated, FC38 can be handled by crane or fork-lift truck, which makes it very easy to mount. The drip-tray of the FC38S is delivered separately. For maintenance and instructions see our manual delivered on order or can be downloaded from our web site www.goedhart.nl.



Fans

GEA Goedhart FC38 aircoolers are executed with Ziehl Abegg: (We reserve the right to alter the manufacturer).

The fans are suitable for operation in air temperatures between -25°C to +40°C. When the air temperature is lower than -25°C, special fans are needed. These special fans have a longer delivery time. The protection class is IP54. The fans are not available with stainless steel protection guards

At all GEA Goedhart FC38 air cooler types (FC38S, FC38D and FC38L) the fans are mounted to the outside of aircooler!

The technical data in the table are the same as on the motor name plates and is valid for an air temperature of +20 °C. Also the data are given for working in an air temperature of 0 °C and -20 °C.

1x230V-50Hz

The standard connection tension for the Ziehl Abegg fans is 230V-50Hz-1 phase for the fan diameters Ø250, Ø300, Ø350, Ø400, Ø450 and Ø500. The fan motors of the Ø250, Ø300 and Ø350 mm fans are standard equipped with internally connected thermo contacts. Ø400, Ø450 and Ø500 mm fans are equipped with thermal contacts lead outside.

3x400V-50Hz

The EBMpapst Ø400, Ø450 and Ø500 fan is on request available in 230/400V-50Hz-3 phase. The fan is executed with a thermal contact lead to the outside.

Connecting thermal contacts

If the thermal contacts are not connected the warranty on the fans expires.

Frequency controlling

When a frequency converter is applied, always an All pole sinus filter should be used!

| Fan type | Values at 1x230V-50Hz | | | | | Sound power indication ach fan LwA (+/-2dB(A)) | Wiring diagram |
|---------------------------------------|-----------------------|-------|-------|------|-------|--|----------------|
| | Speed | Input | +20°C | 0°C | -20°C | | |
| | | | FLC | FLC | FLC | | |
| rpm | [W] | [A] | [A] | [A] | [dBA] | | |
| 4 pole fans (1500 rpm nominal) | | | | | | | |
| FN025 | 1370 | 50 | 0,24 | 0,26 | 0,28 | 62 | 177X |
| FN030 | 1290 | 90 | 0,39 | 0,43 | 0,45 | 65 | 177X |
| FN035 | 1260 | 170 | 0,75 | 0,82 | 0,87 | 75 | 177X |
| FN040 | 1370 | 240 | 1,10 | 1,20 | 1,28 | 76 | 104XB |
| FN045 | 1320 | 550 | 2,50 | 2,73 | 2,90 | 80 | 104XB |
| FN050 | 1230 | 750 | 3,30 | 3,60 | 3,83 | 81,5 | 104XB |
| 6 pole fans (1000 tpm nominal) | | | | | | | |
| FN040 | 950 | 130 | 0,58 | 0,63 | 0,67 | 68 | 104XB |
| FN045 | 910 | 190 | 0,90 | 0,98 | 1,04 | 68,5 | 104XB |
| FN050 | 910 | 300 | 1,30 | 1,42 | 1,51 | 71,5 | 104XB |

| Fan type | Values at 3x400V(Δ)-50Hz | | | | | Sound power indication ach fan LwA (+/-2dB(A)) | Wiring diagram |
|---------------------------------------|--------------------------|-------|-------|------|-------|--|----------------|
| | Speed | Input | +20°C | 0°C | -20°C | | |
| | | | FLC | FLC | FLC | | |
| rpm | [W] | [A] | [A] | [A] | [dBA] | | |
| 4 pole fans (1500 rpm nominal) | | | | | | | |
| FN040 | 1370 | 230 | 0,40 | 0,44 | 0,46 | 76 | 108XB |
| FN045 | 1250 | 350 | 0,64 | 0,69 | 0,74 | 78 | 108XB |
| FN050 | 1300 | 770 | 1,70 | 1,85 | 1,97 | 81 | 108XB |

Wiring diagram

Ziehl Abegg 1x230V-50Hz (177X)

U2= blue or grey
Z2= black
TB=braun

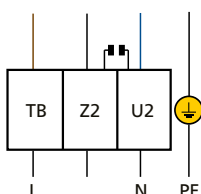

Ziehl Abegg 3x400V (Δ)-50Hz (108XB)

U1 =braun
V1 =blue
W1=black
U2 =red
V2 =grey
W2=orange
TB =white

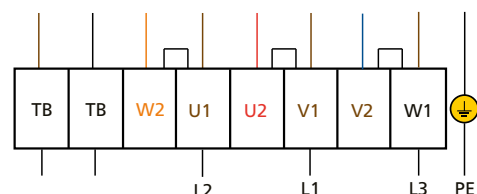

Ziehl Abegg 1x230V-50Hz (104XB)

U1 =braun
U2 =blue
Z1 =black
Z2 =orange
TB =white

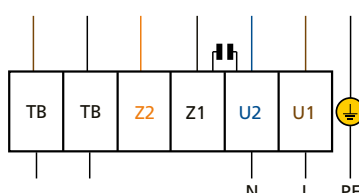

Ziehl Abegg 3x400V (Y)-50Hz (108XB)

U1 =braun
V1 =blue
W1=black
U2 =red
V2 =grey
W2=orange
TB =white

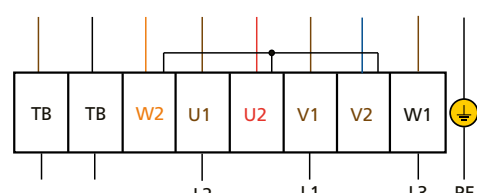

Correction factors

Correction factors DT1 (=Air-on)

The nominal capacities of the Goedhart FC38i(dx) and FC38p(dx) air coolers are based on R-404A direct expansion, DT1 and a RH of 85%. DT1 is the difference between air-on temperature and the evaporation temperature of the cooler. The evaporation temperature is the saturated temperature corresponding to the pressure at the suction outlet of the cooler.

The nominal capacities:

- (SC1) $t_o = 0\text{ °C}$ and DT1= 10 K
- (SC2) $t_o = -8\text{ °C}$ and DT1= 8 K
- (SC3) $t_o = -25\text{ °C}$ and DT1= 7 K

Correction factors for various evaporation temperatures and temperature differences (DT1) are as indicated in the tables below. The requested capacity must be multiplied by a correction factor from the table, so that a cooler with the resulting nominal capacity can be chosen from the selection tables.

Q nominal = factor x Q requested

| R404A | | | | | | | | | | |
|-------|------------------------------|------|------|------|------|------|------|------|------|------|
| DT1 | Evaporation temperature (°C) | | | | | | | | | |
| K | +7 | +6 | +5 | +4 | +3 | +2 | +1 | 0 | -1 | -2 |
| 6 | 1,81 | 1,81 | 1,82 | 1,82 | 1,83 | 1,83 | 1,84 | 1,84 | 1,84 | 1,85 |
| 7 | 1,49 | 1,50 | 1,50 | 1,50 | 1,51 | 1,51 | 1,52 | 1,52 | 1,52 | 1,53 |
| 8 | 1,27 | 1,28 | 1,28 | 1,29 | 1,29 | 1,29 | 1,30 | 1,30 | 1,30 | 1,31 |
| 9 | 1,10 | 1,10 | 1,11 | 1,11 | 1,12 | 1,12 | 1,13 | 1,13 | 1,13 | 1,14 |
| 10 | 0,97 | 0,98 | 0,98 | 0,99 | 0,99 | 0,99 | 1,00 | 1,00 | 1,00 | 1,01 |
| 11 | 0,88 | 0,88 | 0,88 | 0,89 | 0,89 | 0,90 | 0,90 | 0,90 | 0,90 | 0,91 |
| 12 | 0,79 | 0,79 | 0,79 | 0,80 | 0,80 | 0,81 | 0,81 | 0,81 | 0,81 | 0,82 |

SC1 DT1 = 10K
Air on = 10°C (0/+10°C)

| R404A | | | | | | | | | | |
|-------|------------------------------|------|------|------|------|------|------|------|------|------|
| DT1 | Evaporation temperature (°C) | | | | | | | | | |
| K | -3 | -4 | -5 | -6 | -7 | -8 | -9 | -10 | -11 | -12 |
| 6 | 1,30 | 1,34 | 1,38 | 1,42 | 1,42 | 1,43 | 1,43 | 1,43 | 1,44 | 1,44 |
| 7 | 1,04 | 1,07 | 1,10 | 1,14 | 1,17 | 1,18 | 1,18 | 1,18 | 1,19 | 1,19 |
| 8 | 0,86 | 0,88 | 0,91 | 0,94 | 0,97 | 1,00 | 1,00 | 1,01 | 1,01 | 1,01 |
| 9 | 0,75 | 0,75 | 0,77 | 0,79 | 0,82 | 0,84 | 0,87 | 0,87 | 0,87 | 0,88 |
| 10 | 0,66 | 0,66 | 0,66 | 0,68 | 0,70 | 0,72 | 0,74 | 0,77 | 0,77 | 0,77 |
| 11 | 0,59 | 0,59 | 0,59 | 0,59 | 0,61 | 0,63 | 0,65 | 0,67 | 0,69 | 0,69 |
| 12 | 0,54 | 0,54 | 0,54 | 0,54 | 0,54 | 0,55 | 0,57 | 0,58 | 0,60 | 0,62 |

SC2 DT1 = 8K
Air on = 0°C (-8/0°C)

| R404A | | | | | | | | | | |
|-------|------------------------------|------|------|------|------|------|------|------|------|------|
| DT1 | Evaporation temperature (°C) | | | | | | | | | |
| K | -21 | -22 | -23 | -24 | -25 | -26 | -27 | -28 | -29 | -30 |
| 6 | 1,20 | 1,20 | 1,21 | 1,21 | 1,21 | 1,22 | 1,22 | 1,23 | 1,23 | 1,23 |
| 7 | 0,99 | 0,99 | 0,99 | 1,00 | 1,00 | 1,00 | 1,00 | 1,01 | 1,01 | 1,02 |
| 8 | 0,84 | 0,84 | 0,84 | 0,85 | 0,85 | 0,85 | 0,85 | 0,86 | 0,86 | 0,86 |
| 9 | 0,73 | 0,73 | 0,73 | 0,73 | 0,73 | 0,74 | 0,74 | 0,74 | 0,74 | 0,75 |
| 10 | 0,64 | 0,64 | 0,64 | 0,64 | 0,65 | 0,65 | 0,65 | 0,65 | 0,66 | 0,66 |
| 11 | 0,57 | 0,57 | 0,57 | 0,58 | 0,58 | 0,58 | 0,58 | 0,58 | 0,59 | 0,59 |
| 12 | 0,52 | 0,52 | 0,52 | 0,52 | 0,52 | 0,52 | 0,53 | 0,53 | 0,53 | 0,53 |

SC3 DT1 = 7K
Air on = -18°C (-25/-18°C)

Capacity optimization

To achieve the best possible combination of application, refrigerant and capacity, Goedhart can optimise the coil circuiting, depending on the specific conditions under which the products will be used. FC38 is a standard product to ensure shorter delivery times. The circuiting of these evaporators has been optimized according to the most commonly used coolants/refrigerants and conditions. Specific applications can vary from this, our sales department is there to assist you in selecting the best circuiting for your application.

Correction factors for coolants

The nominal capacities of the Goedhart FC38p(G) air coolers are based on an air-on temperature of 12°C, a RH of 85% and:

- Water : in / out temperatuur = +1/+5°C
- E-Glycol : in / out temperatuur = - 2/+3°C
- P-Glycol : in / out temperatuur = - 2/+3°C
- Pekasol : in / out temperatuur = - 2/+3°C
- Freezium : in / out temperatuur = - 2/+3°C

Correction factors for various air-on temperatures and refrigerants or secondary coolants are as indicated in the tables below. The requested capacity must be multiplied by a correction factor from the table, so that a cooler with the resulting nominal capacity can be chosen from the selection tables.

Q nominal = faktor x Q requested

| Water | | | | | | | | | | |
|--------|-------------------------|------|------|------|------|------|------|------|------|--|
| in/out | Air-on temperature (°C) | | | | | | | | | |
| °C | +8 | +9 | +10 | +11 | +12 | +13 | +14 | +15 | +16 | |
| 1 / 5 | 1,99 | 1,59 | 1,32 | 1,14 | 1,00 | 0,88 | 0,78 | 0,72 | 0,66 | |
| 2 / 6 | | 1,95 | 1,57 | 1,30 | 1,12 | 0,98 | 0,87 | 0,78 | 0,71 | |
| 3 / 7 | | | 1,92 | 1,54 | 1,28 | 1,11 | 0,97 | 0,86 | 0,77 | |
| 4 / 8 | | | | 1,94 | 1,56 | 1,31 | 1,13 | 0,98 | 0,87 | |
| 5 / 9 | | | | | 1,86 | 1,49 | 1,25 | 1,07 | 0,94 | |

| E-Glycol 28% | | | | | | | | | | |
|--------------|-------------------------|------|------|------|------|------|------|------|------|--|
| in/out | Air-on temperature (°C) | | | | | | | | | |
| °C | +8 | +9 | +10 | +11 | +12 | +13 | +14 | +15 | +16 | |
| -2 / 3 | 1,81 | 1,46 | 1,34 | 1,16 | 1,00 | 0,88 | 0,82 | 0,81 | 0,69 | |
| -1 / 4 | 2,35 | 1,72 | 1,41 | 1,28 | 1,10 | 0,96 | 0,85 | 0,79 | 0,75 | |
| 0 / 5 | 2,43 | 2,30 | 1,64 | 1,40 | 1,24 | 1,06 | 0,93 | 0,84 | 0,76 | |
| 1 / 6 | | 2,38 | 2,28 | 1,59 | 1,37 | 1,21 | 1,05 | 0,92 | 0,82 | |
| 2 / 7 | | | 2,28 | 2,09 | 1,55 | 1,35 | 1,17 | 1,03 | 0,91 | |

| P-Glycol 28% | | | | | | | | | | |
|--------------|-------------------------|------|------|------|------|------|------|------|------|--|
| in/out | Air-on temperature (°C) | | | | | | | | | |
| °C | +8 | +9 | +10 | +11 | +12 | +13 | +14 | +15 | +16 | |
| -2 / 3 | 1,66 | 1,45 | 1,26 | 1,11 | 1,00 | 0,91 | 0,83 | 0,76 | 0,70 | |
| -1 / 4 | 2,00 | 1,65 | 1,42 | 1,24 | 1,11 | 1,01 | 0,90 | 0,81 | 0,77 | |
| 0 / 5 | 2,48 | 1,94 | 1,65 | 1,41 | 1,23 | 1,14 | 1,00 | 0,91 | 0,85 | |
| 1 / 6 | | 2,46 | 1,97 | 1,64 | 1,42 | 1,29 | 1,12 | 1,00 | 0,92 | |
| 2 / 7 | | | 2,45 | 1,96 | 1,63 | 1,64 | 1,28 | 1,11 | 1,00 | |

| Pekasol 50% | | | | | | | | | | |
|-------------|-------------------------|------|------|------|------|------|------|------|------|--|
| in/out | Air-on temperature (°C) | | | | | | | | | |
| °C | +8 | +9 | +10 | +11 | +12 | +13 | +14 | +15 | +16 | |
| -2 / 3 | 1,68 | 1,42 | 1,26 | 1,11 | 1,00 | 0,90 | 0,82 | 0,77 | 0,70 | |
| -1 / 4 | 2,02 | 1,65 | 1,42 | 1,24 | 1,10 | 0,98 | 0,89 | 0,81 | 0,76 | |
| 0 / 5 | 2,39 | 1,96 | 1,62 | 1,39 | 1,22 | 1,07 | 0,96 | 0,87 | 0,80 | |
| 1 / 6 | | 2,36 | 1,93 | 1,60 | 1,37 | 1,20 | 1,06 | 0,94 | 0,86 | |
| 2 / 7 | | | 2,32 | 1,89 | 1,57 | 1,35 | 1,18 | 1,05 | 0,94 | |

| Freezium 24% | | | | | | | | | | |
|--------------|-------------------------|------|------|------|------|------|------|------|------|--|
| in/out | Air-on temperature (°C) | | | | | | | | | |
| °C | +8 | +9 | +10 | +11 | +12 | +13 | +14 | +15 | +16 | |
| -2 / 3 | 1,66 | 1,44 | 1,25 | 1,11 | 1,00 | 0,91 | 0,83 | 0,77 | 0,71 | |
| -1 / 4 | 1,94 | 1,62 | 1,42 | 1,23 | 1,09 | 0,98 | 0,89 | 0,82 | 0,76 | |
| 0 / 5 | 2,38 | 1,91 | 1,59 | 1,39 | 1,21 | 1,07 | 0,97 | 0,88 | 0,81 | |
| 1 / 6 | | 2,34 | 1,88 | 1,57 | 1,37 | 1,20 | 1,06 | 0,95 | 0,86 | |
| 2 / 7 | | | 2,30 | 1,86 | 1,55 | 1,35 | 1,18 | 1,05 | 0,94 | |

Goedhart FC38Si(dx) - R404A

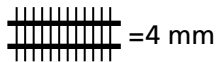

| Type | Fan diameter | 1x230V-50Hz-4 pole (1500 min ⁻¹ nom.) | | | | | Surface | Connections | | Weight | Internal volume |
|----------|--------------|--|--|---|-------------------|-----------------------------|----------------|-------------|----|--------|-----------------|
| | | SC1 DT1 = 10K Air on =10°C 0 / +10 | SC2 DT1 = 8K Air on =0°C -8 / 0 | SC3 DT1 = 7K Air on =-18°C -25 / -18 | Air volume | LpA @ 3 m (+/- 2 dB(A))* | | I | K | | |
| FC38S | mm | kW | kW | kW | m ³ /h | dB(A) | m ² | mm | mm | kg | dm ³ |
| 4.1.25.4 | 1x250 | 2,4 | 1,7 | | 632 | 40,8 | 7 | 12 | 12 | 26 | 2 |
| 4.1.30.4 | 1x300 | 4,0 | 2,7 | | 1124 | 43,7 | 11 | 12 | 28 | 34 | 3 |
| 6.1.30.4 | 1x300 | 4,4 | 3,1 | | 980 | 43,7 | 16 | 12 | 28 | 39 | 4 |
| 6.1.35.4 | 1x350 | 7,7 | 5,3 | | 1794 | 53,5 | 25 | 12 | 28 | 51 | 6 |
| 6.1.40.4 | 1x400 | 10,7 | 7,3 | | 2531 | 54,4 | 34 | 16 | 28 | 63 | 8 |
| 6.1.45.4 | 1x450 | 17,7 | 12,0 | | 4565 | 58,3 | 45 | 16 | 28 | 75 | 10 |
| 4.2.30.4 | 2x300 | 7,9 | 5,4 | | 2241 | 46,5 | 22 | 12 | 28 | 50 | 5 |
| 6.2.30.4 | 2x300 | 8,8 | 6,1 | | 1952 | 46,5 | 32 | 12 | 28 | 61 | 7 |
| 6.2.35.4 | 2x350 | 15,4 | 10,5 | | 3578 | 56,3 | 50 | 16 | 28 | 82 | 11 |
| 6.2.40.4 | 2x400 | 21,3 | 14,5 | | 5051 | 57,1 | 68 | 16 | 35 | 103 | 15 |
| 6.2.45.4 | 2x450 | 35,3 | 23,9 | | 9115 | 61,0 | 90 | 16 | 35 | 122 | 19 |
| 6.2.50.4 | 2x500 | 43,4 | 29,4 | | 11131 | 62,3 | 112 | 16 | 42 | 204 | 24 |
| 6.3.30.4 | 3x300 | 13,2 | 9,1 | | 2923 | 48,1 | 49 | 16 | 28 | 81 | 11 |
| 6.3.35.4 | 3x350 | 23,0 | 15,8 | | 5363 | 57,8 | 75 | 16 | 28 | 112 | 16 |
| 6.3.40.4 | 3x400 | 32,3 | 22,2 | | 7570 | 58,6 | 102 | 16 | 35 | 142 | 22 |
| 6.3.45.4 | 3x450 | 52,9 | 35,8 | | 13665 | 62,5 | 134 | 16 | 42 | 174 | 28 |
| 6.3.50.4 | 3x500 | 65,4 | 44,4 | | 16686 | 63,8 | 168 | 16 | 54 | 291 | 35 |
| 6.4.30.4 | 4x300 | 17,5 | 12,0 | | 3895 | 49,2 | 65 | 16 | 28 | 104 | 14 |
| 6.4.35.4 | 4x350 | 30,6 | 21,0 | | 7148 | 58,9 | 99 | 16 | 35 | 143 | 21 |
| 6.4.40.4 | 4x400 | 43,1 | 29,4 | | 10089 | 59,7 | 136 | 22 | 42 | 183 | 29 |
| 6.4.45.4 | 4x450 | 70,7 | 47,8 | | 18214 | 63,5 | 179 | 22 | 54 | 222 | 38 |
| 6.4.50.4 | 4x500 | 87,0 | 58,9 | | 22242 | 64,7 | 224 | 28 | 54 | 376 | 47 |
| 6.5.45.4 | 5x450 | 89,0 | 60,1 | | 22764 | 64,2 | 223 | 22 | 54 | 267 | 47 |
| 6.6.45.4 | 6x450 | 106,2 | 71,5 | | 27314 | 64,7 | 268 | 28 | 54 | 322 | 56 |

Air cooler details

* = Sound pressure indication (LpA) at 3 m distance each air cooler (+/- 2 dB(A)) , free field conditions, according EN13487

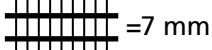

| Type | Fan diameter | 1x230V-50Hz-4 pole (1500 min ⁻¹ nom.) | | | | | Surface | Connections | | Weight | Internal volume |
|----------|--------------|--|--|---|-------------------|-----------------------------|----------------|-------------|----|--------|-----------------|
| | | SC1 DT1 = 10K Air on =10°C 0 / +10 | SC2 DT1 = 8K Air on =0°C -8 / 0 | SC3 DT1 = 7K Air on =-18°C -25 / -18 | Air volume | LpA @ 3 m (+/- 2 dB(A))* | | I | K | | |
| FC38S | mm | kW | kW | kW | m ³ /h | dB(A) | m ² | mm | mm | kg | dm ³ |
| 4.1.25.7 | 1x250 | 1,8 | 1,2 | 0,9 | 720 | 40,8 | 4 | 12 | 12 | 25 | 2 |
| 4.1.30.7 | 1x300 | 3,0 | 2,0 | 1,5 | 1309 | 43,7 | 7 | 12 | 28 | 32 | 3 |
| 6.1.30.7 | 1x300 | 3,9 | 2,6 | 1,9 | 1194 | 43,7 | 10 | 12 | 28 | 36 | 4 |
| 6.1.35.7 | 1x350 | 6,4 | 4,4 | 3,2 | 2103 | 53,5 | 15 | 12 | 28 | 46 | 6 |
| 6.1.40.7 | 1x400 | 9,0 | 6,1 | 4,5 | 2964 | 54,4 | 21 | 16 | 28 | 57 | 8 |
| 6.1.45.7 | 1x450 | 14,1 | 9,5 | 6,9 | 5217 | 58,3 | 27 | 16 | 28 | 67 | 10 |
| 4.2.30.7 | 2x300 | 5,9 | 4,0 | 2,9 | 2612 | 46,5 | 13 | 12 | 28 | 47 | 5 |
| 6.2.30.7 | 2x300 | 7,7 | 5,2 | 3,9 | 2381 | 46,5 | 19 | 12 | 28 | 56 | 7 |
| 6.2.35.7 | 2x350 | 12,8 | 8,7 | 6,4 | 4199 | 56,3 | 30 | 16 | 28 | 74 | 11 |
| 6.2.40.7 | 2x400 | 17,6 | 12,1 | 8,7 | 5918 | 57,1 | 41 | 16 | 28 | 92 | 15 |
| 6.2.45.7 | 2x450 | 28,1 | 18,9 | 13,9 | 10423 | 61,0 | 54 | 16 | 35 | 109 | 19 |
| 6.2.50.7 | 2x500 | 34,7 | 23,4 | 17,2 | 12823 | 62,3 | 67 | 16 | 35 | 186 | 24 |
| 6.3.30.7 | 3x300 | 11,5 | 7,8 | 5,8 | 3568 | 48,1 | 29 | 12 | 28 | 74 | 11 |
| 6.3.35.7 | 3x350 | 19,3 | 13,1 | 9,6 | 6295 | 57,8 | 45 | 16 | 28 | 100 | 16 |
| 6.3.40.7 | 3x400 | 26,8 | 18,3 | 13,4 | 8873 | 58,6 | 61 | 16 | 28 | 126 | 22 |
| 6.3.45.7 | 3x450 | 42,0 | 28,2 | 20,5 | 15628 | 62,5 | 80 | 16 | 42 | 152 | 28 |
| 6.3.50.7 | 3x500 | 52,0 | 35,0 | 25,8 | 19226 | 63,8 | 101 | 16 | 42 | 263 | 35 |
| 6.4.30.7 | 4x300 | 15,0 | 10,3 | 7,6 | 4754 | 49,2 | 39 | 16 | 28 | 93 | 14 |
| 6.4.35.7 | 4x350 | 25,7 | 17,5 | 12,7 | 8389 | 58,9 | 60 | 16 | 35 | 127 | 21 |
| 6.4.40.7 | 4x400 | 35,5 | 24,1 | 17,9 | 11828 | 59,7 | 82 | 16 | 35 | 161 | 29 |
| 6.4.45.7 | 4x450 | 56,3 | 37,7 | 27,7 | 20834 | 63,5 | 107 | 16 | 42 | 193 | 38 |
| 6.4.50.7 | 4x500 | 69,7 | 46,7 | 34,3 | 25630 | 64,7 | 134 | 28 | 54 | 339 | 47 |
| 6.5.45.7 | 5x450 | 70,2 | 47,0 | 34,7 | 26040 | 64,2 | 134 | 22 | 54 | 229 | 47 |
| 6.6.45.7 | 6x450 | 84,4 | 56,5 | 40,9 | 31246 | 64,7 | 161 | 22 | 54 | 279 | 56 |

Air cooler details

* = Sound pressure indication (LpA) at 3 m distance each air cooler (+/- 2 dB(A)) , free field conditions, according EN13487

Goedhart FC38Di(dx) - R404A

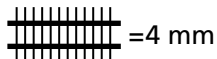

| Type | Fan diameter | 1x230V-50Hz-4 pole | | | | 1x230V-50Hz-6 pole | | | | Surface | Connections | | Weight | Internal volume |
|----------|--------------|--------------------------------------|-----------------------------------|------------|-----------------------------|--------------------------------------|-----------------------------------|------------|-----------------------------|----------------|-------------|----|--------|-----------------|
| | | SC1 | SC2 | | | SC1 | SC2 | | | | I | K | | |
| FC38D | mm | DT1 = 10K Air on =10°C 0 / +10 | DT1 = 8K Air on =0°C -8 / 0 | Air volume | LpA @ 3 m (+/- 2 dB(A))* | DT1 = 10K Air on =10°C 0 / +10 | DT1 = 8K Air on =0°C -8 / 0 | Air volume | LpA @ 3 m (+/- 2 dB(A))* | m ² | mm | mm | kg | dm ³ |
| 6.1.30.4 | 1x300 | 4,3 | 2,9 | 954 | 43,7 | | | | | 16 | 12 | 28 | 54 | 4 |
| 6.1.35.4 | 1x350 | 6,5 | 4,4 | 1597 | 53,5 | | | | | 20 | 12 | 28 | 66 | 6 |
| 6.2.30.4 | 2x300 | 8,3 | 5,7 | 1858 | 46,5 | | | | | 30 | 12 | 28 | 82 | 8 |
| 6.2.35.4 | 2x350 | 11,8 | 8,0 | 2908 | 56,3 | | | | | 34 | 16 | 28 | 92 | 8 |
| 6.2.40.4 | 2x400 | 19,1 | 12,9 | 4697 | 57,1 | 15,2 | 10,5 | 3326 | 49,1 | 61 | 16 | 35 | 123 | 14 |
| 6.2.45.4 | 2x450 | 36,1 | 24,5 | 9276 | 61,0 | 26,2 | 18,1 | 5919 | 49,5 | 95 | 16 | 42 | 161 | 20 |
| 6.3.30.4 | 3x300 | 12,8 | 8,9 | 2873 | 48,1 | | | | | 48 | 16 | 28 | 114 | 10 |
| 6.3.35.4 | 3x350 | 16,7 | 11,4 | 4150 | 57,8 | | | | | 48 | 16 | 28 | 116 | 10 |
| 6.3.40.4 | 3x400 | 29,4 | 20,2 | 7051 | 58,6 | 22,9 | 15,8 | 4993 | 50,6 | 91 | 16 | 35 | 169 | 20 |
| 6.3.45.4 | 3x450 | 54,9 | 37,3 | 14031 | 62,5 | 39,4 | 27,2 | 8964 | 51,0 | 146 | 22 | 42 | 228 | 32 |
| 6.4.30.4 | 4x300 | 16,6 | 11,4 | 3721 | 49,2 | | | | | 61 | 16 | 28 | 138 | 14 |
| 6.4.35.4 | 4x350 | 21,5 | 14,7 | 5376 | 58,9 | | | | | 61 | 16 | 28 | 139 | 14 |
| 6.4.40.4 | 4x400 | 36,3 | 24,8 | 8832 | 59,7 | 28,1 | 19,4 | 6262 | 51,7 | 110 | 16 | 42 | 200 | 24 |

* = Sound pressure indication (LpA) at 3 m distance each air cooler (+/- 2 dB(A)), free field conditions, according EN13487

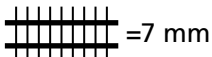

| Type | Fan diameter | 1x230V-50Hz-4 pole | | | | 1x230V-50Hz-6 pole | | | | Surface | Connections | | Weight | Internal volume |
|----------|--------------|--------------------------------------|-----------------------------------|------------|-----------------------------|--------------------------------------|-----------------------------------|------------|-----------------------------|----------------|-------------|----|--------|-----------------|
| | | SC1 | SC2 | | | SC1 | SC2 | | | | I | K | | |
| FC38D | mm | DT1 = 10K Air on =10°C 0 / +10 | DT1 = 8K Air on =0°C -8 / 0 | Air volume | LpA @ 3 m (+/- 2 dB(A))* | DT1 = 10K Air on =10°C 0 / +10 | DT1 = 8K Air on =0°C -8 / 0 | Air volume | LpA @ 3 m (+/- 2 dB(A))* | m ² | mm | mm | kg | dm ³ |
| 6.1.30.7 | 1x300 | 3,7 | 2,5 | 1167 | 43,7 | | | | | 10 | 12 | 28 | 51 | 4 |
| 6.1.35.7 | 1x350 | 5,3 | 3,5 | 1918 | 53,5 | | | | | 12 | 12 | 28 | 62 | 6 |
| 6.2.30.7 | 2x300 | 7,1 | 4,9 | 2288 | 46,5 | | | | | 18 | 12 | 28 | 77 | 8 |
| 6.2.35.7 | 2x350 | 9,8 | 6,7 | 3562 | 56,3 | | | | | 21 | 12 | 28 | 87 | 8 |
| 6.2.40.7 | 2x400 | 16,3 | 11,0 | 5625 | 57,1 | 13,1 | 9,0 | 3976 | 49,1 | 36 | 16 | 28 | 114 | 14 |
| 6.2.45.7 | 2x450 | 28,3 | 19,1 | 10479 | 61,0 | 21,7 | 14,8 | 6804 | 49,5 | 57 | 16 | 35 | 145 | 20 |
| 6.3.30.7 | 3x300 | 11,1 | 7,6 | 3509 | 48,1 | | | | | 29 | 16 | 28 | 107 | 10 |
| 6.3.35.7 | 3x350 | 14,0 | 9,5 | 5131 | 57,8 | | | | | 29 | 12 | 28 | 109 | 10 |
| 6.3.40.7 | 3x400 | 24,4 | 16,6 | 8441 | 58,6 | 29,6 | 13,3 | 5967 | 50,6 | 55 | 16 | 35 | 154 | 20 |
| 6.3.45.7 | 3x450 | 42,8 | 28,9 | 15801 | 62,5 | 33,0 | 22,6 | 10266 | 51,0 | 88 | 16 | 42 | 203 | 32 |
| 6.4.30.7 | 4x300 | 14,3 | 9,8 | 4581 | 49,2 | | | | | 36 | 16 | 28 | 128 | 14 |
| 6.4.35.7 | 4x350 | 18,1 | 12,2 | 6682 | 58,9 | | | | | 36 | 16 | 28 | 129 | 14 |
| 6.4.40.7 | 4x400 | 30,4 | 20,6 | 10796 | 59,7 | 24,6 | 16,9 | 7630 | 51,7 | 66 | 16 | 35 | 181 | 24 |

* = Sound pressure indication (LpA) at 3 m distance each air cooler (+/- 2 dB(A)), free field conditions, according EN13487



Excellence

Passion

Integrity

Responsibility

GEA-versity

GEA Group is a global mechanical engineering company with multi-billion euro sales and operations in more than 50 countries. Founded in 1881 the company is one of the largest providers of innovative equipment and process technology. GEA Group is listed in the STOXX Europe 600 Index.



GEA Heat Exchangers

GEA Goedhart B.V.

Nijverheidsweg 6, 4695 RC Sint Maartensdijk
The Netherlands
Phone +31 (0)166 665 665, Fax+31 (0)166 663 698
www.goedhart.nl,
info.goedhart.nl@geagroup.com

GEA Heat Exchangers

GEA Goedhart s.r.o.

Kostomlátecká 180, 288 26 Nymburk
Czech Republic
Phone +420 325 519 951, Fax+420 325 519 952
www.goedhart.cz,
goedhart.cz@geagroup.com